

# NMOS linear image sensor

## S5930/S5931 series

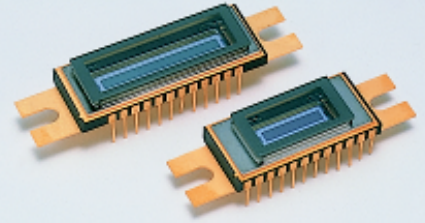

Built-in thermoelectric cooler ensures long exposure time and stable operation.

NMOS linear image sensors are self-scanning photodiode arrays designed specifically as detectors for multichannel spectroscopy. The scanning circuit is made up of N-channel MOS transistors, operates at low power consumption and is easy to handle. Each photodiode has a large active area, high UV sensitivity yet very low noise. The built-in thermoelectric cooler (air cooled) allows a long exposure time achieving a high S/N even at low light levels. The cap uses a sapphire glass window hermetically welded for high reliability.

### Features

- Wide active area  
Pixel pitch: 50  $\mu\text{m}$  (S5930 series)  
25  $\mu\text{m}$  (S5931 series)  
Pixel height: 2.5 mm
- High UV sensitivity with good stability
- Low dark current and high saturation charge allow a long integration time and a wide dynamic range at room temperature
- Excellent output linearity and sensitivity spatial uniformity
- Start pulse and clock pulses are CMOS logic compatible
- Built-in air-cooled thermoelectric cooler  
(setting temperature: 0 °C)

### Applications

- Multichannel spectrophotometry
- Image readout system

### ■ Selection guide

Type No.	Number of pixels	Pixel size [ $\mu\text{m}$ (H) $\times$ $\mu\text{m}$ (V)]	Active area size [mm (H) $\times$ mm (V)]
S5930-256S	256	50 $\times$ 2500	12.8 $\times$ 2.5
S5930-512S	512		25.6 $\times$ 2.5
S5931-512S	512	25 $\times$ 2500	12.8 $\times$ 2.5
S5931-1024S	1024		25.6 $\times$ 2.5

In addition to S5930/S5931 series, Hamamatsu provides S8382/S8383 series thermoelectrically cooled NMOS linear image sensors that offer higher sensitivity in the near IR range. Major characteristics of S8382/S8383 series are almost identical with S5930/S5931 series except that the peak sensitivity wavelength is 750 nm (see Figure 5) and the saturation charge is 90 mC/s.

**Figure 1 Equivalent circuit**

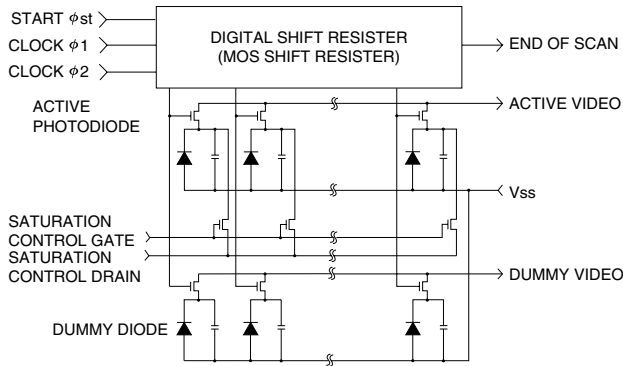

KMPDC0020EA

**Figure 2 Active area structure**

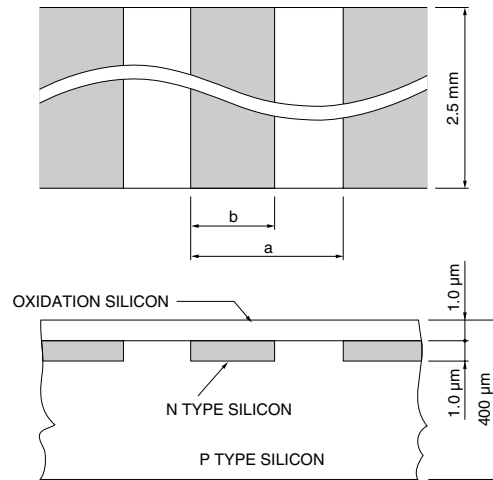

S5930 SERIES: a=50 μm, b=45 μm  
S5931 SERIES: a=25 μm, b=20 μm

KMPDA0132EA

**■ Absolute maximum ratings**

Parameter	Symbol	Value	Unit
Input pulse (φ1, φ2, φst) voltage	Vφ	15	V
Operating temperature*1	Topr	-40 to +65	°C
Storage temperature	Tstg	-40 to +85	°C

\*1: No condensation. Ambient temperature should be less than the element cooling temperature +35 °C. (Example: Ambient temperature should be less than 35 °C in order to keep the element temperature at 0 °C.)

**■ Specifications (Ta=25 °C, unless otherwise noted)**

Parameter	Symbol	S5930 series			S5931 series			Unit	
		Min.	Typ.	Max.	Min.	Typ.	Max.		
Pixel pitch	-	-	50	-	-	25	-	μm	
Pixel height	-	-	2.5	-	-	2.5	-	mm	
Spectral response range (10 % of peak)	λ	200 to 1000			200 to 1000			nm	
Peak sensitivity wavelength	λp	-	600	-	-	600	-	nm	
Photodiode dark current*2	Id	25 °C	-	0.2	0.6	-	0.1	0.3	pA
		0 °C	-	0.006	0.018	-	0.003	0.009	
Photodiode capacitance*2	Cph	-	20	-	-	10	-	pF	
Saturation exposure*2, *3	Esat	-	180	-	-	180	-	m/x · s	
Saturation output charge*2	Qsat	-	50	-	-	25	-	pC	
Photo response non-uniformity*4	PRNU	-	-	±3	-	-	±3	%	

\*2: Vb=2.0 V, Vφ=5.0 V

\*3: 2856 K, tungsten lamp

\*4: 50 % of saturation, excluding the start pixel and last pixel

■ Electrical characteristics (Ta=25 °C)

Parameter	Symbol	Condition	S5930 series			S5931 series			Unit
			Min.	Typ.	Max.	Min.	Typ.	Max.	
Clock pulse ( $\phi 1, \phi 2$ ) voltage	High	$V_{\phi 1}, V_{\phi 2}$ (H)	4.5	5	10	4.5	5	10	V
	Low	$V_{\phi 1}, V_{\phi 2}$ (L)	0	-	0.4	0	-	0.4	V
Start pulse ( $\phi st$ ) voltage	High	$V_{\phi s}$ (H)	4.5	$V_{\phi 1}$	10	4.5	$V_{\phi 1}$	10	V
	Low	$V_{\phi s}$ (L)	0	-	0.4	0	-	0.4	V
Video bias voltage *5	$V_b$		1.5	$V_{\phi} - 3.0$	$V_{\phi} - 2.5$	1.5	$V_{\phi} - 3.0$	$V_{\phi} - 2.5$	V
Saturation control gate voltage	$V_{scg}$		-	0	-	-	0	-	V
Saturation control drain voltage	$V_{scd}$		-	$V_b$	-	-	$V_b$	-	V
Clock pulse ( $\phi 1, \phi 2$ ) rise/fall time *6	$tr_{\phi 1}, tr_{\phi 2}$ $tf_{\phi 1}, tf_{\phi 2}$		-	20	-	-	20	-	ns
Clock pulse ( $\phi 1, \phi 2$ ) pulse width	$tpw_{\phi 1}, tpw_{\phi 2}$		200	-	-	200	-	-	ns
Start pulse ( $\phi st$ ) rise/fall time	$tr_{\phi s}, tf_{\phi s}$		-	20	-	-	20	-	ns
Start pulse ( $\phi st$ ) pulse width	$tpw_{\phi s}$		200	-	-	200	-	-	ns
Start pulse ( $\phi st$ ) and clock pulse ( $\phi 2$ ) overlap	$t_{\phi ov}$		200	-	-	200	-	-	ns
Clock pulse space *6	$X_1, X_2$		$trf - 20$	-	-	$trf - 20$	-	-	ns
Data rate *7	$f$		0.1	-	2000	0.1	-	2000	kHz
Video delay time	$t_{vd}$	50 % of saturation *7, *8	-	120 (-256S)	-	-	150 (-512S)	-	ns
			-	160 (-512S)	-	-	200 (-1024S)	-	ns
Clock pulse ( $\phi 1, \phi 2$ ) line capacitance	$C_{\phi}$	5 V bias	-	36 (-256S)	-	-	50 (-512S)	-	pF
			-	67 (-512S)	-	-	100 (-1024S)	-	pF
Saturation control gate ( $V_{scg}$ ) line capacitance	$C_{scg}$	5 V bias	-	20 (-256S)	-	-	24 (-512S)	-	pF
			-	35 (-512S)	-	-	45 (-1024S)	-	pF
Video line capacitance	$C_v$	2 V bias	-	11 (-256S)	-	-	16 (-512S)	-	pF
			-	20 (-512S)	-	-	30 (-1024S)	-	pF

\*5:  $V_{\phi}$  is input pulse voltage.

\*6:  $trf$  is the clock pulse rise or fall time. A clock pulse space of "rise time/fall time - 20" ns (nanoseconds) or more should be input if the clock pulse rise or fall time is longer than 20 ns.

\*7:  $V_b=2.0$  V,  $V_{\phi}=5.0$  V

\*8: Measured with C7883 driver circuit.

Figure 3 Dimensional outlines (unit: mm)

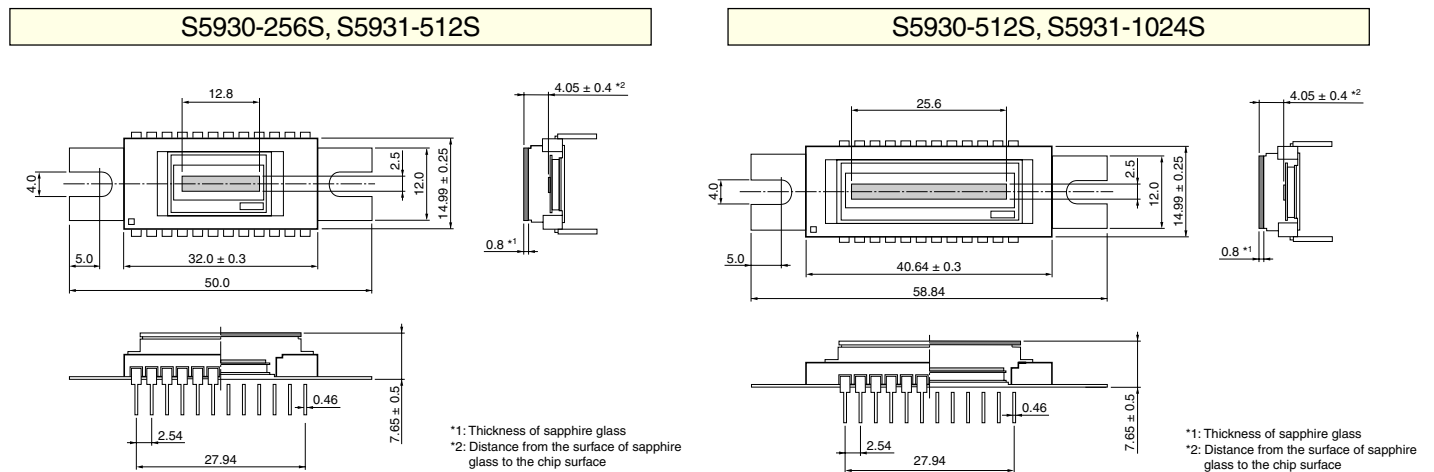
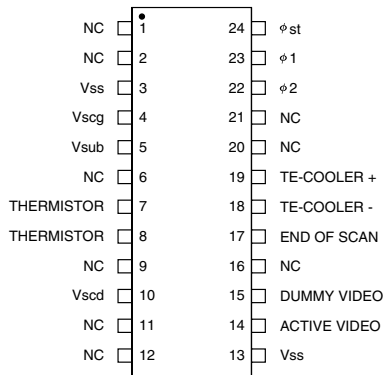

Figure 4 Pin connection



Vss, Vsub and NC should be grounded.  
Electricity flows between the 20th pin and package metal.

KMPDC0115EA

Terminal	Input or output	Description
φ1, φ2	Input (CMOS logic compatible)	Pulses for operating the MOS shift register. The video data rate is equal to the clock pulse frequency since the video output signal is obtained synchronously with the rise of φ2 pulse.
φst	Input (CMOS logic compatible)	Pulse for starting the MOS shift register operation. The time interval between start pulses is equal to the signal accumulation time.
Vss	-	Connected to the anode of each photodiode. This should be grounded.
Vscg	Input	Used for restricting blooming. This should be grounded.
Vscd	Input	Used for restricting blooming. This should be biased at a voltage equal to the video bias voltage.
Active video	Output	Video output signal. Connects to photodiode cathodes when the address is on. A positive voltage should be applied to the video line in order to use photodiodes with a reverse voltage. When the amplitude of φ1 and φ2 is 5 V, a video bias voltage of 2 V is recommended.
Dummy video	Output	This has the same structure as the active video, but is not connected to photodiodes, so only spike noise is output. This should be biased at a voltage equal to the active video or left as an open-circuit when not needed.
Vsub	-	Connected to the silicon substrate. This should be grounded.
End of scan	Output (CMOS logic compatible)	This should be pulled up at 5 V by using a 10 kΩ resistor. This is a negative going pulse that appears synchronously with the φ2 timing right after the last photodiode is addressed.
NC	-	Should be grounded.
TE-cooler	Input	For sensor chip cooling
Thermistor	Output	For temperature control

Figure 5 Spectral response (typical example)

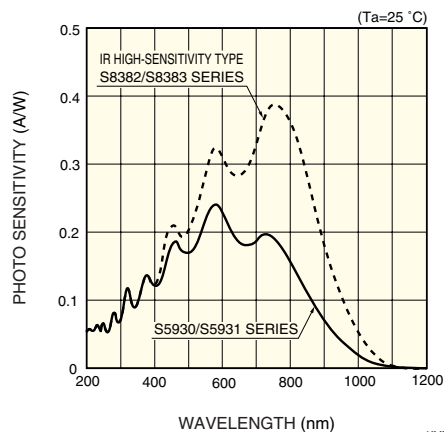

KMPDB0163EA

Figure 6 Output charge vs. exposure

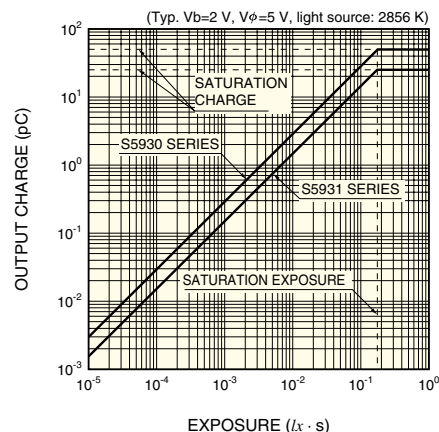

KMPDB0164EA

■ TE-cooler type 1 (T-06E 144P-RNO) characteristics  
(built-in S5930-512S, S5931-1024S)

Parameter	Condition	Value	Unit
Built-in resistance	Ta=25 °C	1.25	Ω
Maximum current	Tc -Th=20 °C	3.6	A
Maximum voltage	Tc -Th=80 °C	6.2	V
Maximum heat absorption	Tc -Th=20 °C	7.5	W

Figure 7 Voltage vs. temperature (Tc=0 °C)

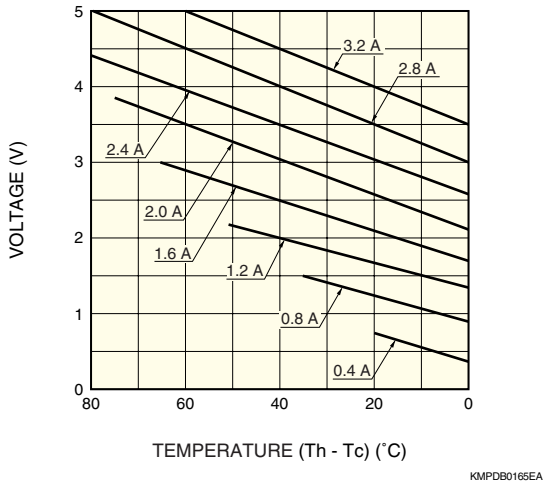

Figure 8 Heat absorption vs. temperature (Tc=0 °C)

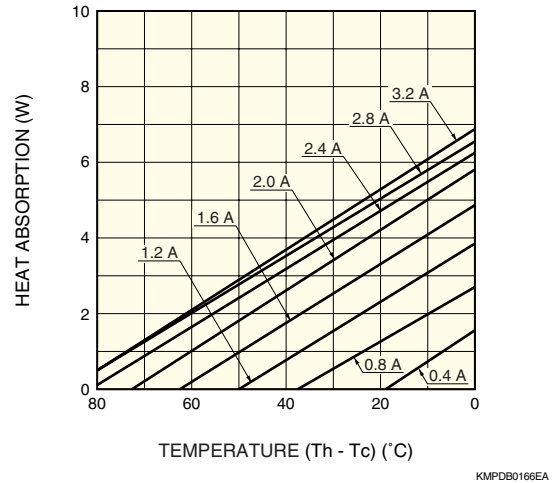

Figure 9 Voltage vs. temperature (Tc=20 °C)

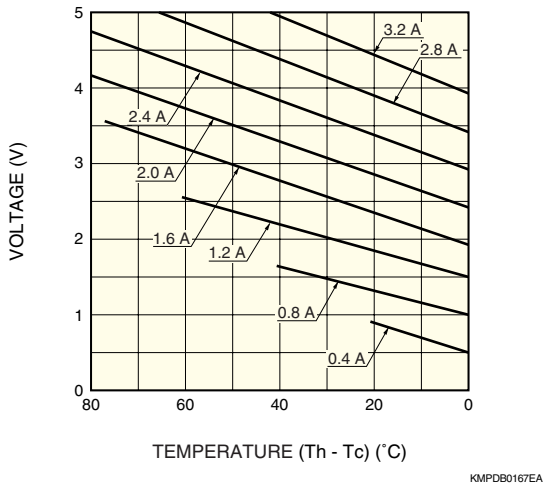
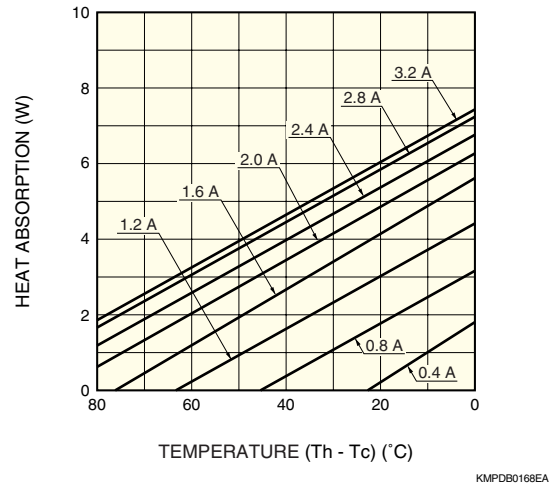

Figure 10 Heat absorption vs. temperature (Tc=20 °C)



■ Thermister characteristics

Characteristics

Parameter	Condition	Value	Unit
Resistance	Ta=25 °C	10	kΩ
B-constant		3450	k
Operating temperature		-40 to +100	°C

Resistance vs. temperature

Temperature (°C)	Resistance (kΩ)
-20	78.4
-10	46.7
0	28.1
10	18.2
20	12.2
25	10.0
30	8.3
40	5.7

■ TE-cooler type 2 (T-06E 108P-RNO) characteristics  
(built-in S5930-256S, S5931-512S)

Parameter	Condition	Value	Unit
Built-in resistance	Ta=25 °C	0.983	Ω
Maximum current	Tc -Th=20 °C	3.6	A
Maximum voltage	Tc -Th=80 °C	4.7	V
Maximum heat absorption	Tc -Th=20 °C	5.7	W

Figure 11 Voltage vs. temperature (Tc=0 °C)

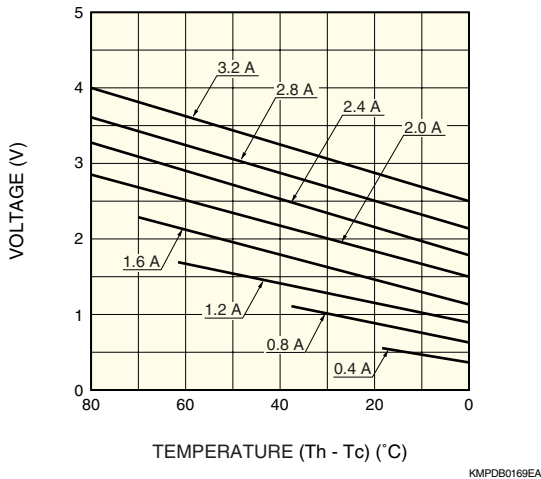

Figure 12 Heat absorption vs. temperature (Tc=0 °C)

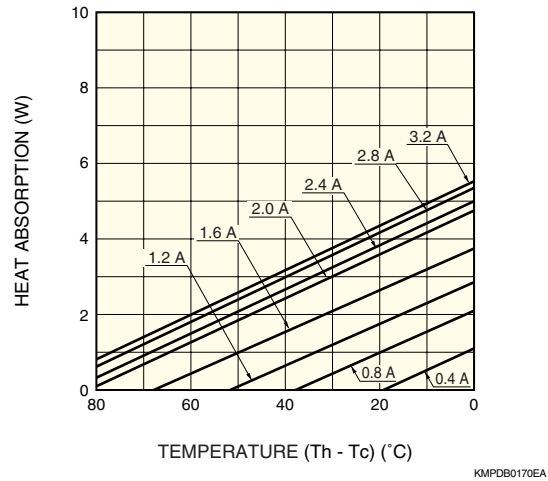

Figure 13 Voltage vs. temperature (Tc=20 °C)

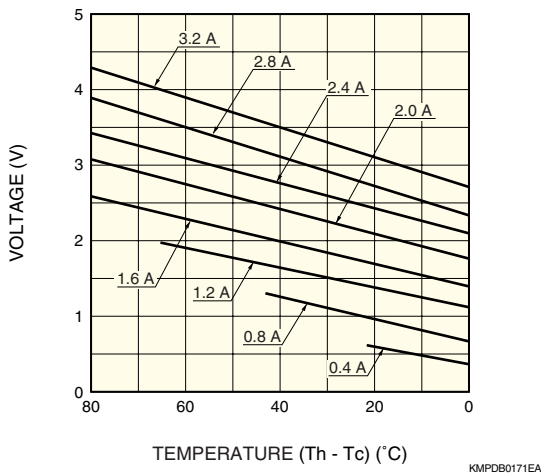

Figure 14 Heat absorption vs. temperature (Tc=20 °C)

